

SWIT®

S-2610/S-2620/S-2630
Flexible SMD LED Light
Ver: B

USER MANUAL

SWIT Electronics Co.,Ltd.

Tel:+86-25-85805753
Fax:+86-25-85805296
http://www.swit.cc
E-mail: contact@swit.cc

Congratulations on your purchase of this product. Please read this user manual carefully.

Caution

1. Do not disassemble the light or touch the interior of the light with metal objects, so as not to cause damage;
2. Please avoid storing lights in dusty or humid environment to avoid damaging or affecting the usage;
3. Please avoid hard scratches in the light, so as not to affect the usage;
4. Use a clean cloth to wipe the surface of the light if there is slight oil stains and stains;
5. When using the 2.4 G wireless cascading control function, please make sure the antenna is perfectly installed.

Specifications

Model	S-2610	S-2620	S-2630
LED	504pcs	280pcs	756pcs
Color Temperature	3000K-5600K		
Brightness	0%-100%		
Luminance	2400 Lux/1m	1200 Lux/1m	3900 Lux/1m
Beam Angle	10°-360°		
CRI	≥97		
TLCI	≥97		
Input	100W	50W	150W
Voltage	DC 11-17V/AC100-240V		
Dimensions	600mm x 460mm	455mm x 315mm	600mm x 600mm
Weight	Light: 0.46Kg Control Box: 0.84Kg Adaptor: 0.43Kg	Light: 0.29Kg Control Box: 0.81Kg Adaptor: 0.29Kg	Light: 0.7Kg Control Box: 1.1Kg Adaptor: 0.84Kg

Appearance

1. Front View:

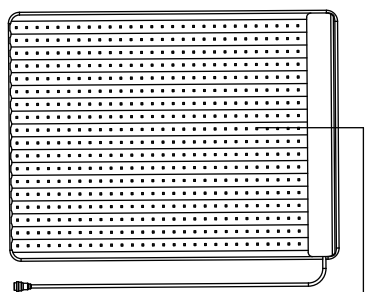

Fig1 S-2610

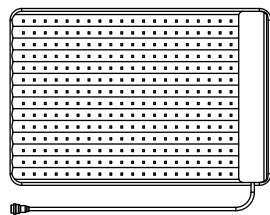

Fig2 S-2620

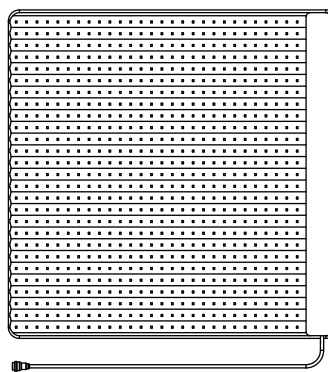

Fig3 S-2630

2.Rear View:

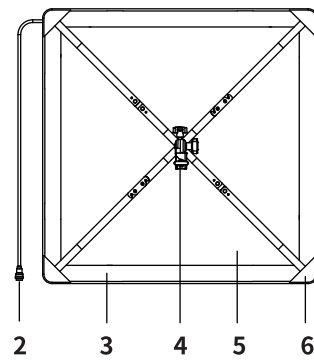

Fig4 S-2630 (for example)

3.Control Box:

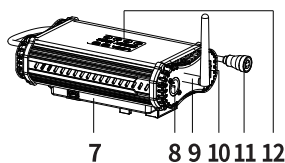

Fig5 S-2610

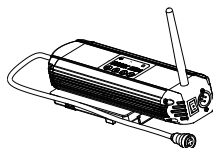

Fig6 S-2620



Fig7 S-2630

- 1 LED light bar
- 2 Light input connection cable
- 3 Velcro tape
- 4 X-frame
- 5 Light body
- 6 Wrap angle
- 7 V-mount battery plate
- 8 Power input interface
- 9 Antenna
- 10 Power on/off
- 11 Control box output cable
- 12 LCD

LCD Display

For example: Color temperature: 4500K, brightness 100%

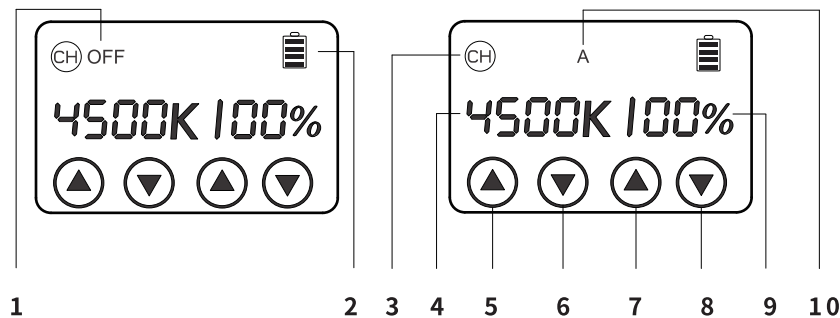

Fig8
2.4 G wireless cascading control function is off

Fig9
2.4 G wireless cascading control function is on

- 1 Wireless cascading control function off
- 2 Battery status
- 3 Wireless cascading control button
- 4 CT display
- 5 CT increase button
- 6 CT decrease button
- 7 Brightness increase button
- 8 Brightness decrease button
- 9 Brightness display
- 10 Current wireless control channel

Usage

1. Install

1.1 Light body installation

The user selects the appropriate installation method based on the usage requirements:

- (1).The light is thin, soft and light weight so it can bend to use
- (2).Joint the light using the Velcro tape
- (3).Use the Velcro tape to fix the light on the back of the chair, car roof or other narrow and small places.
- (4).Use the X-frame to fix the light (Fig4)

Note:

For clients who buy diffuser and ball diffuser, please install the X-frame to fix the light first (Fig4), then fix the diffuser and ball diffuser using the Velcro tape.

1.2 Please reliably connect the control box output cable (Fig 5 No.11) with light input connection cable (Fig4 No.2)

Note:

For clients who buy extension cable, please connect the cable between control box output cable and light input connection cable.

2. Power Supply

- (1). Please keep the power switch to OFF
- (2). Power the light through battery or adaptor
 - When using V-mount battery to power the light, please switch to “—”
 - When using the adaptor, please switch to “=”

3. CT and brightness adjustment

Turn on the power switch and set the required color temperature and brightness value by control box.

4. 2.4G wireless cascading control

The light has 2.4 G wireless cascading control function which can realize wireless mutual control among multiple lights. When using this feature, there is no principal and subordinate relationship among the lights. The brightness and color temperature of other lights can be adjusted by any light in the same group. The details are as follows:

- (1). Install the antenna;
- (2). Channel selection can be set according to the requirements through LCD touch screen "CH" from A, B, C and D channels;
- (3). Select one light to change the color temperature and brightness of other lights according to the lighting requirements.

Packing List

	Packing details	Quantity
1	Light	×1
2	Control box	×1
3	Adaptor	×1
4	Power cable	×1
5	X-bracket	×1
6	X-bracket connector	×1
7	Antenna	×1
8	Velcro tape	×1
9	Diffusing cover	×1
10	Carry case	×1
11	User manual	×1
12	Warranty card	×1
13	Ball diffuser (Optional)	Customers can purchase separately according to the requirements.
14	Diffuser with Egg crate (Optional)	
15	Extension cable (4m,6m,8m,10m) (Optional)	